

ROHS COMPLIANT

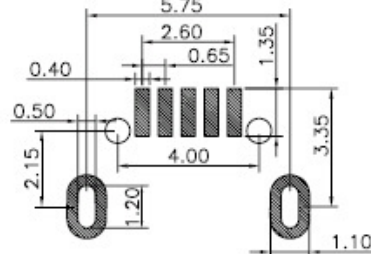
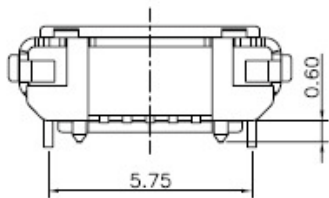
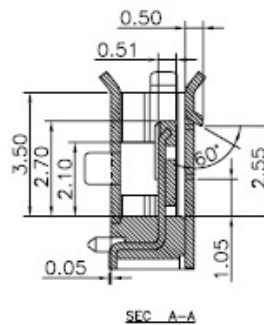
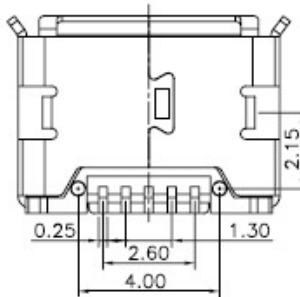
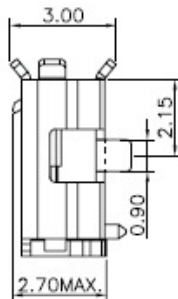
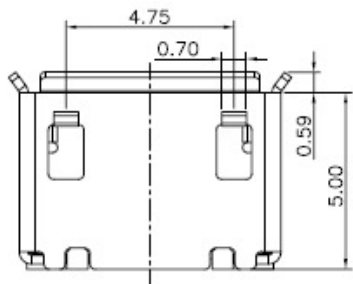
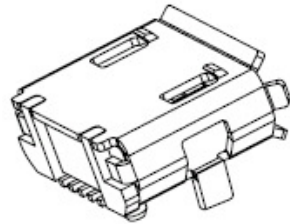
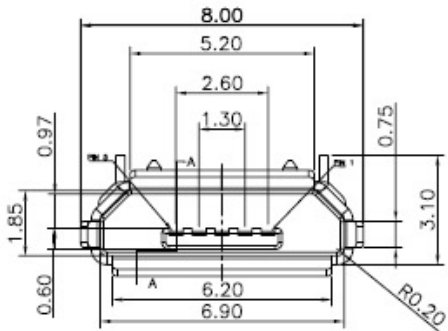
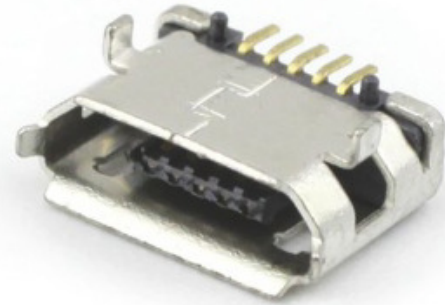

RECOMMENDED P.C.B HOLE LAYOUT

1.Material:

- 1.1 Housing: High temperature thermoplastic with g.f,UL94v-0
- 1.2 Contact: copper alloy,t=0.15mm
- 1.3 Shell: copper alloy,t=0.30mm

2.Specification:

- 2.1 Current rating:1,5PIN 1.8A Max/2,3,4PIN 1A Max
- 2.2 Dielectric withstanding voltage: 100 V(ac) for 1 min.
- 2.3 Contact resistance: 30 mΩ Max.
- 2.4 Insulation resistance: 100 MΩ Min.
- 2.5 Total mating force: 3.57 Kgf Max.
- 2.6 Total unmating force: 1.0 Kgf Min.
- 2.7 Temperature range: -30°C~80°C

PART NUMBER: USB-MICRO-SMD-046

DESCRIPTION: USB MICRO 5P SMD CONNECTOR

DIMENSION TOLERANCE +/- 0.2mm

REV. 0 DATE 28/04/2020

 PRAN ELECTRONICS PVT. LTD.
INDIA.