

PART NUMBER: 60-3S5-095

DESCRIPTION: 12X12X9.5mm STANDARD TACT SWITCH

ROHS COMPLIANT

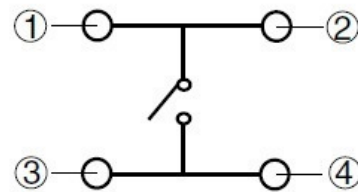
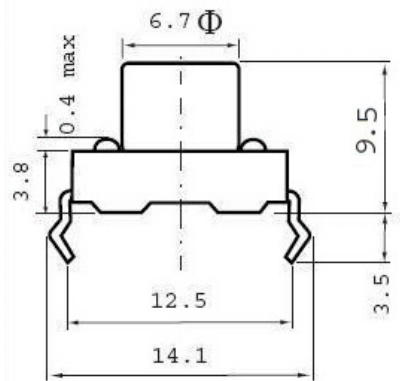
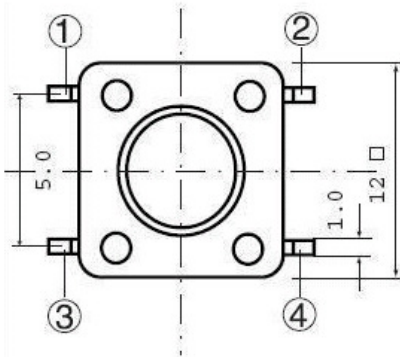
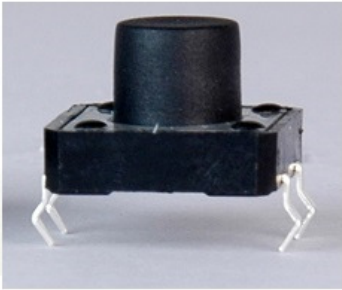

CIRCUIT DIAGRAM

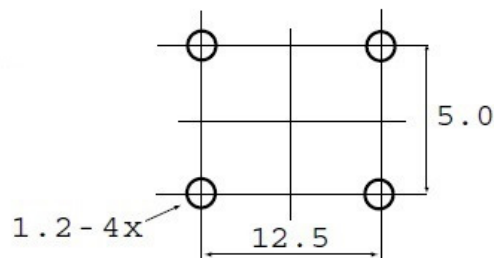

PCB LAYOUT

### SPECIFICATIONS

Items		Standard
Operating temperature range		-30°C to +85°C
Electrical performance	Rating	50mA. 12V DC
	Insulation resistance	100MΩ min. 100V DC
	Dielectric strength	250V AC for 1 min.
	Contact resistance	100mΩ max.
Durability	Lifetime	100,000 Cycles
Mechanical performance	Operating force	180gf 250gf
	Travel	0.25 ± 0.1mm

Dimensional tolerance +/- 0.2mm

REV. 00 DATE 12/07/2017

 PRAN ELECTRONICS PVT. LTD.  
INDIA.